

Frameless

GAS FIREPLACE

THREE SIDED



TECHNICAL INSTRUCTIONS



1- General Marks	3
2- Maxitrol System - Remote Control	4
2.1 - Combination Control - GV60	4
- Mounting Position	5
- Thermocouple Circuit	5
- Ignition Cable G60-ZKIS	5
- Receiver	6
- Adjustment	6
2.2 - Symax Handset	8
- 8 Button operation	8
- 10 Button operation	8
2.3 - Myfire Puck - B6R-H8	8
2.4 - Myfire WIFI Box	9
2.5 - Wiring Diagrams	10
- Basic	10
- Fan,light/dimmer, 2nd burner feature	11
- 2nd Thermocouple	12
- Receiver for power flue control, fan, light/dimmer,2nd burner feature(volt-free contact)	13
- Myfire App Setup	14
3- Connection - Operating Unit	15
4- Installation	16
- Wall Exit	16
- Roof Exit	16
- System Connection possibilities - Concentric flue	17
- Roof exit with a bend	17
- Wall exit with a bend	18
5- Isolation - Decoration	19
- TV Installation above mantshelf	19
- Built-in TV installation	20
6- Ventilation system	21
7- Built-in burner and accessories	22
8- Dimensions - Drawings	23



It is a gas fireplace with a closed combustion system. Made for your comfort and gives a touch to your space. It is a device that produces a source of heat and a real vision of dancing flame. The balanced flues fires are based on the principle of air exchange between oxygen and carbon. The internal pipe ensures the elimination of burnt gases and the external pipe brings in the combustion air. However the equipment operates independently of the atmosphere in the house.

The fireplace is made of high quality steel. It has three layers of 2mm steel, with a cap of 1.5 mm. All steel elements are coated with high-temperature paint. But the fireplace is closed with a vitro ceramic glass, which is known for its high heat resistance. The burner is also made of high-quality steel with holes made of ceramic.

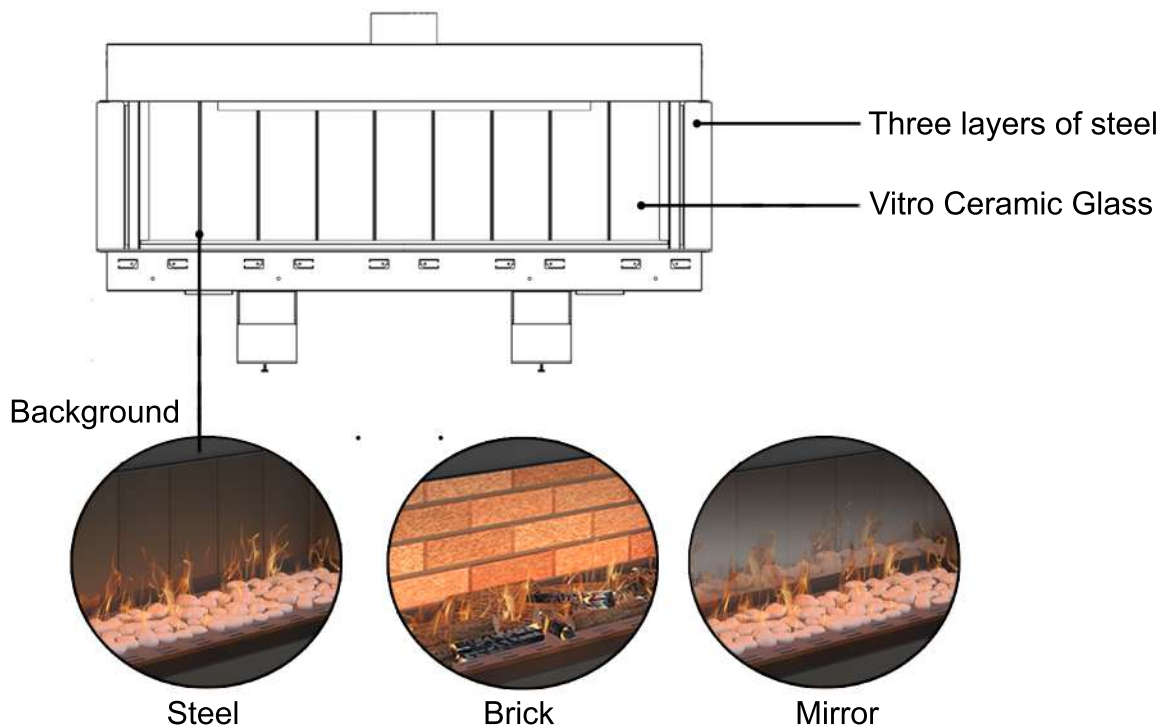

Eco gas is connected to a high complete remote control system - Maxitrol System 2020 - made in germany.

GV Series Gas Control Systems:

The GV Series Gas Control Systems are a comprehensive line of combination gas control systems used to control the pilot and main burner. In addition to standard features and options, these unique systems can be customized for use on a wide range of appliances such as space heaters, fireplaces, griddle plates, storage water heaters, or ovens.



It is the responsibility of the OEM to consider the following:

- The location of the GV60 system components will significantly effect the radio signal strength.
- The type of materials (e.g. sheet metal) used in the construction of the gas fireplace will significantly effect the radio signal strength.
- Operate the system with a dedicated mains power supply and/or batteries.
- Do not use near household electrical wiring and/or magnetic fields.
- Other transmitters using the same signal will negatively affect the radio signal strength.
- Adjustment of the on-board antenna on the receiver can improve signal strength.
- Do not store or locate the GV60 system components in a hot, cold, or humid environment.

2.1- COMBINATION CONTROL - GV60

GV60 is a battery-powered electronic remote ignition and control system for gas appliances with pilot burners and ODS systems. When used with thermostatic remote, the GV60 fully modulates between low fire and high fire. Current applications include fireplaces and log sets. The green On-Demand Pilot feature eliminates energy consumption during extended appliance inactivity by automatically extinguishing the pilot. The GV60 System can be used with Maxitrol's myfire Puck™, Symax® Handsets and myfire® App.

Features:

- Programmable handset
- App-enabled
- Variable ambient light control and circulating fan control
- On-Demand pilot
- Second thermocouple connection



1. Turn off gas supply at the appliance service valve before starting installation, and perform a Gas Leak Test after the installation is complete.
2. Install the sediment trap or filter (where required) in the gas supply line to prevent contamination of the gas valve (see figure 8).
3. Use only your hand to push in or turn the gas control knobs. Never use tools. If a knob will not push in or turn by hand, do not try to repair it. Call a qualified service technician. Force or attempted repair will void warranty and can result in a fire or explosion.

- Mounting Position:

In upright position, gas control knobs are on top of the valve. Valve may be mounted 0° to 90° any direction (including vertical) from the upright position. Valve must NOT be mounted upside down.

LOCATION

Locate the combination gas valve where it is not exposed to steam cleaning, high humidity, dripping water, corrosive chemicals, dust or grease accumulation, or excessive heat.

GV60 standard version is suitable for indoor use only.

- Thermocouple circuit:

Total resistance of thermocouple circuit should be minimized to ensure proper operation.



1. Tighten brass interrupter block into valve ¼ turn beyond finger tight. If necessary, an additional ¼ turn is possible.
2. Slide spade connectors into plastic insert.
3. Slide plastic insert with spade connectors into the brass interrupter block until it snaps
4. While holding the interrupter block with a wrench, thread the thermocouple into the female end of the interrupter block ¼ – ½ turn beyond finger tight

- Ignition Cable G60-ZKIS

AMBIENT TEMPERATURE RANGE

CSA: Ignition Cable: 302 °F

CE: Ignition Cable: 150 °C

CAUTION: Damage and/or interference will occur to the GV electronic system if the ignition cable (high voltage) is not separated from other GV system wiring.

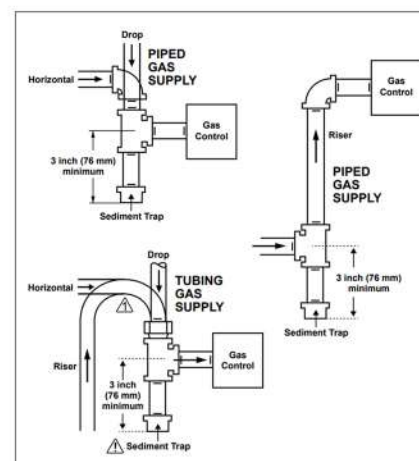

Sediment Trap

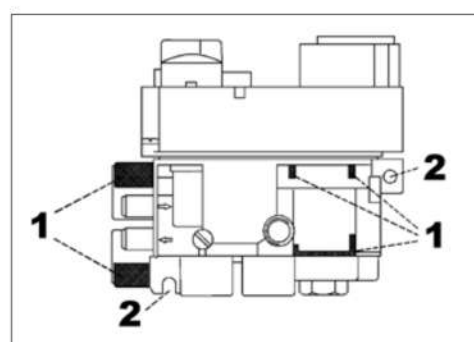

1 = Clamp Areas, 2 = Mounting Points



AMBIENT TEMPERATURE RANGE

- CSA: Receiver without internal batteries: 32 °F to 176 °F
- Receiver with internal batteries: 32 °F to 131 °F
- CE: Receiver without internal batteries: 0 °C to 80 °C
- Receiver with internal batteries: 0 °C to 55 °C

RADIO FREQUENCY

- CSA: 915 MHz for U.S. and for Canada (handset, receiver)
- CE: 868 MHz for Europe (handset, receiver)

POWER CONSUMPTION (STANDBY)

- CSA + CE: G6R-R3(4)... : 0.8 mW
- G6R-R0AM... : 0.4 mW
- B6R-R8(9)... : 0.7 mW

POWER CONSUMPTION (NOMINAL)

- CSA + CE: G6R-R3(4)... : 0.8 mW
- G6R-R0AM... : 0.4 mW
- B6R-R8(9)... : 0.8 mW

POWER CONSUMPTION (MOTOR TURN)

- CSA + CE: G6R-R3(4)... : 0.25 W
- G6R-R0AM... : 0.25 W
- B6R-R8(9)... : 0.25 W

POWER CONSUMPTION (IGNITION)

- CSA + CE: G6R-R3(4)... : 3.0 W
- G6R-R0AM... : 3.0 W
- B6R-R8(9)... : 3.0 W

POWER SUPPLY

- Receiver: 4 x 1.5V "AA" (quality alkaline recommended)
- An AC mains adapter may be used instead of batteries.

- Adjustment

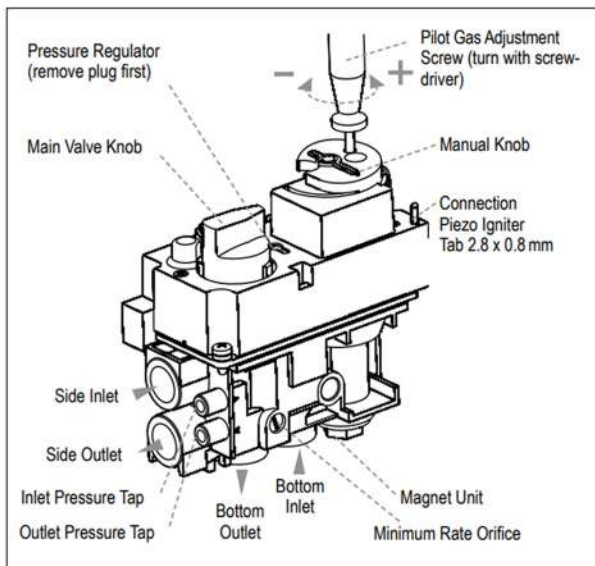

GV60, Connections and Adjustment Options

Pilot Flame Adjustment

(Vented Units Only)

The pilot flow adjustment is preset to maximum at the factory. The pilot flame should envelope $\frac{3}{8}$ " to $\frac{1}{2}$ " of the thermocouple

1. The adjustment screw can be reached through a hole in the MANUAL knob
2. Turn the MANUAL knob to the **ON** position.
3. It is now possible to pierce through a film on the cover with a screwdriver to reach the adjustment screw beneath.
4. Turn the adjustment screw clockwise to decrease or counterclockwise to increase pilot flame.

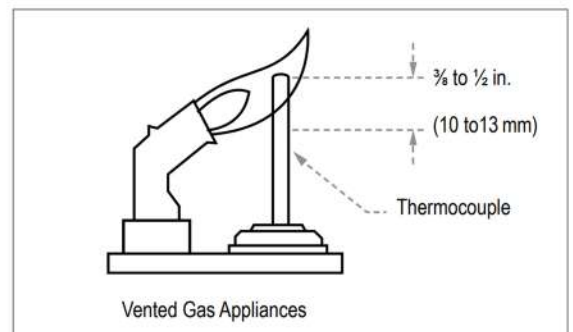

Proper Flame Impingement on Thermocouple





Outlet Pressure Adjustment

(Vented Units Only)

STANDARD REGULATOR OR THROTTLE

(Throttle CE Only)

1. Connect a pressure manometer to the valve outlet pressure tap. Pressure tap is opened by turning the screw counterclockwise .
Pressure regulator or throttle are located under the cover and can be reached by removing the plug
2. Turn MANUAL knob and main valve knob to the **ON** position.
3. Turn pressure regulator adjustment screw to set required burner pressure (high fire). Pressure is increased by turning clockwise  (pressure regulator models), or decreased by turning counterclockwise .



Combination Control GV60, Cover

4. After adjustment, replace the plug.
5. If no other adjustments are required, close pressure tap(s) by turning the screw(s) full clockwise .
Check all connections / pressure tap(s) for leaks.
6. If the desired outlet pressure or flow cannot be achieved by adjusting the gas valve, check the gas valve inlet pressure using a manometer at the valve inlet pressure tap. If the inlet pressure is in the normal range, replace the gas valve; otherwise, take necessary steps to assure proper gas pressure to the valve.



Conversion Plug

Conversion from one gas to another

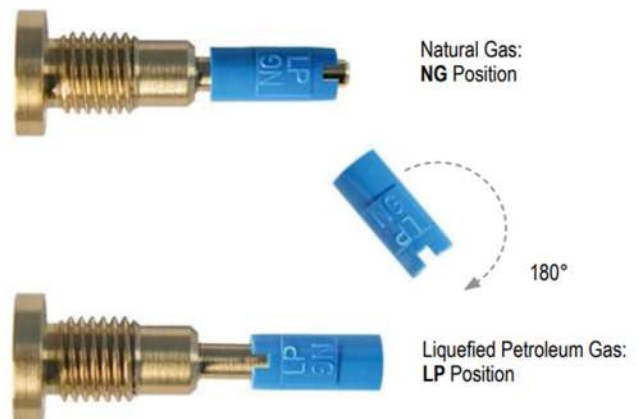

2.2 - SYMAX HANDSET

- 8 Button operation:

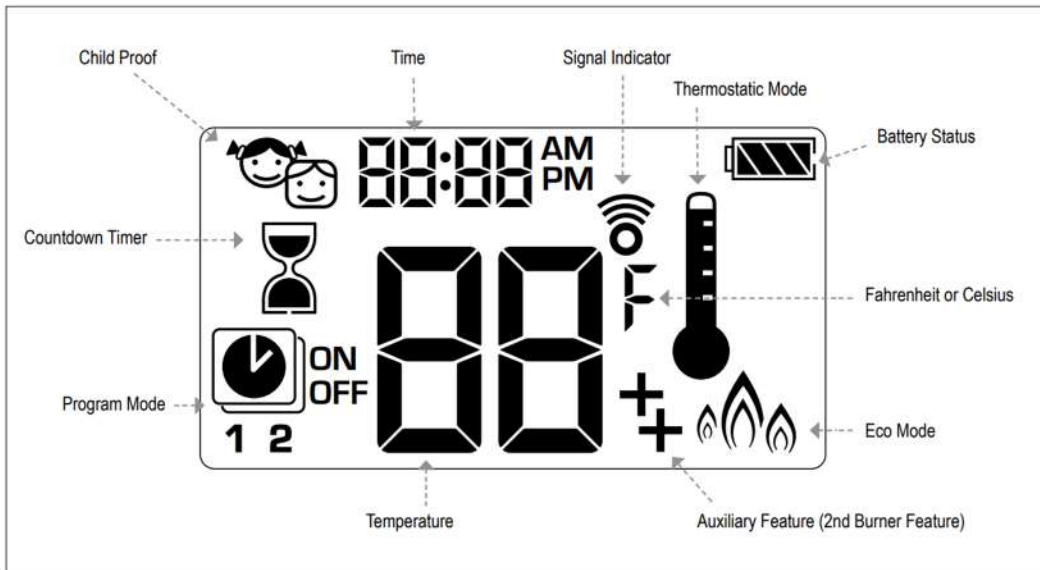

- 10 Button operation:

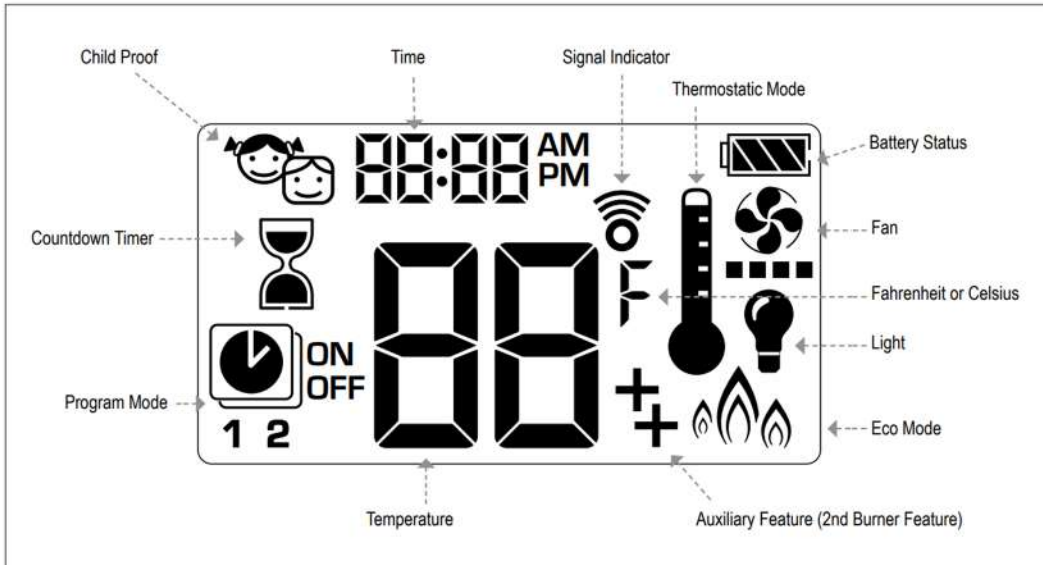

2.3 - MYFIRE PUCK - B6R-H8

The new myfire Puck is simple in form and function. It's a smart control that works in conjunction with the GV60/Symax system. Its basic functions turn the fire on and off and adjust the flame height.

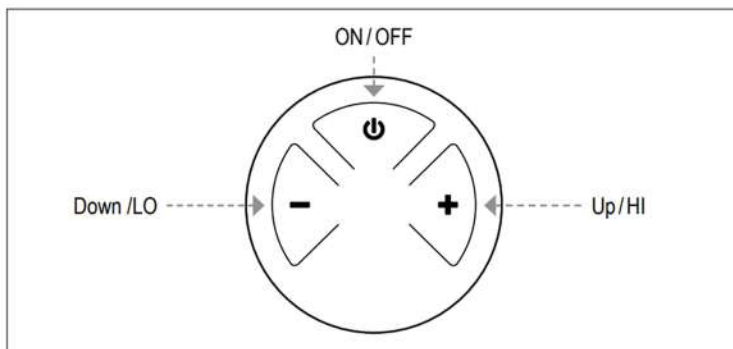

3-button layout



Improvements include faster processing speed, new Wi-Fi chip, and best of all for the customer, an uncomplicated and much shorter setup menu for the myfire App.

The new Wi-Fi Box also has a variable power supply between 5 and 24 volts, two RGB outlets, identical connectors on both ends of the cable, and the Wi-Fi Box itself has a much smaller footprint for easy installation in tight spaces.

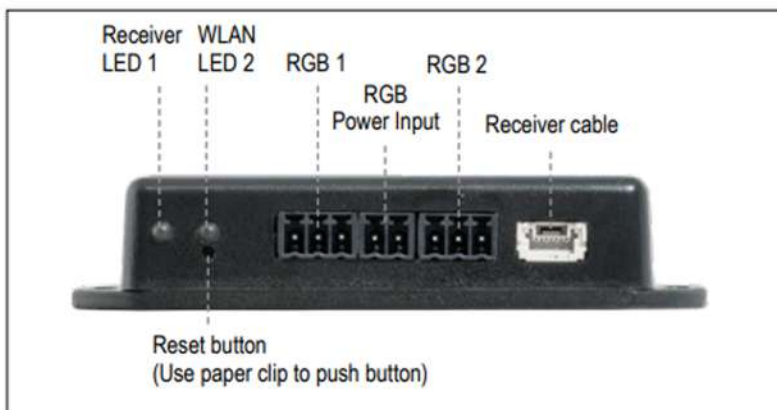

myfire Wi-Fi Box (B6R-W2...)

LED INDICATION ON MYFIRE WI-FI BOX 2 RGB LEDs

Label	LED	Status
Receiver LED 1	Green	Connected to receiver.
	Red	Not connected to receiver.
	Off	Standby mode is active or no Power supply.
WLAN LED 2	Green	Wi-Fi connection is safe.
	Blue/Green blinking	Access point mode (AP mode) is active.
	Red	Not connected to home network (Wi-Fi Router).
	Off	Standby mode is active or no power supply.

RESET STATUS ON MYFIRE WI-FI BOX:

Press Reset Button	LED	Function
Power-On-Reset or 1-sec-Reset	WLAN LED 2 flashes red, green and blue	If no network is set, the AP Mode will be activated for 2 hours. When the network isn't set after 2 hours, the Wi-Fi Box will go to Standby Mode. Once a network is set, the Wi-Fi Box will connect directly.
7 secs	WLAN LED 1 flashes every 500 ms in blue	Removes the Wi-Fi settings and turns on the Access point mode (AP mode) for 2 hours.
20 secs	WLAN LED 1 flashes every 50 ms in blue	Erases all Setup Data. The Wi-Fi chip will be set to the last version after the reboot. The AP-Mode will be activated for 2 hours.



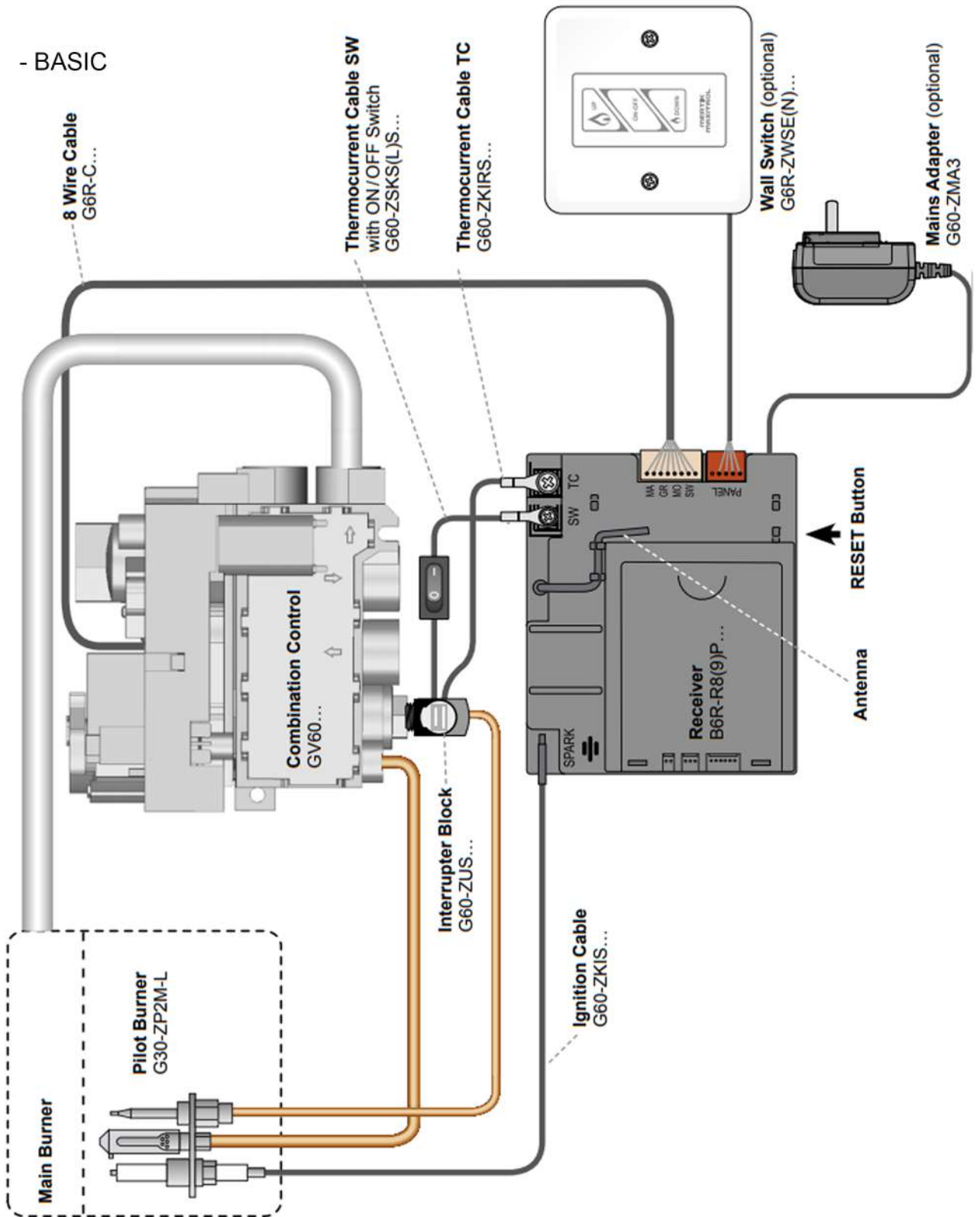

Additional functions

The universal receivers B6R-R8(9)P... and B6R-R8(9)PT... can be used to start a power flue control (2pin outlet) or to operate a second burner or a relay (3pin outlet). Together with a module, the receiver controls a circulating fan and a dimmer.

The receiver B6R-R8(9)PT... has main burner supervision (2nd thermocouple option). This option is programmed so that it cannot be used without the second thermocouple installed and vice versa.



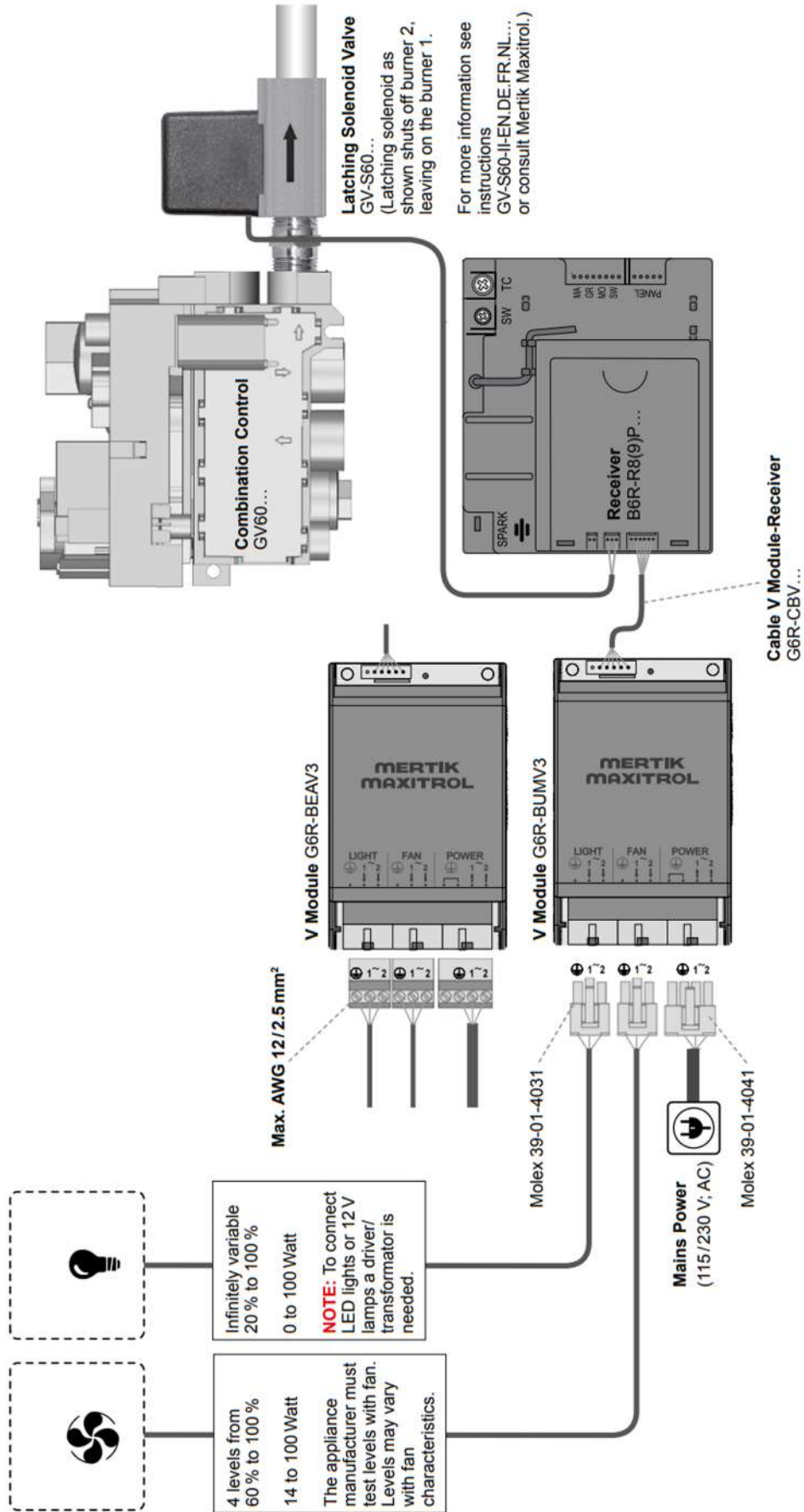

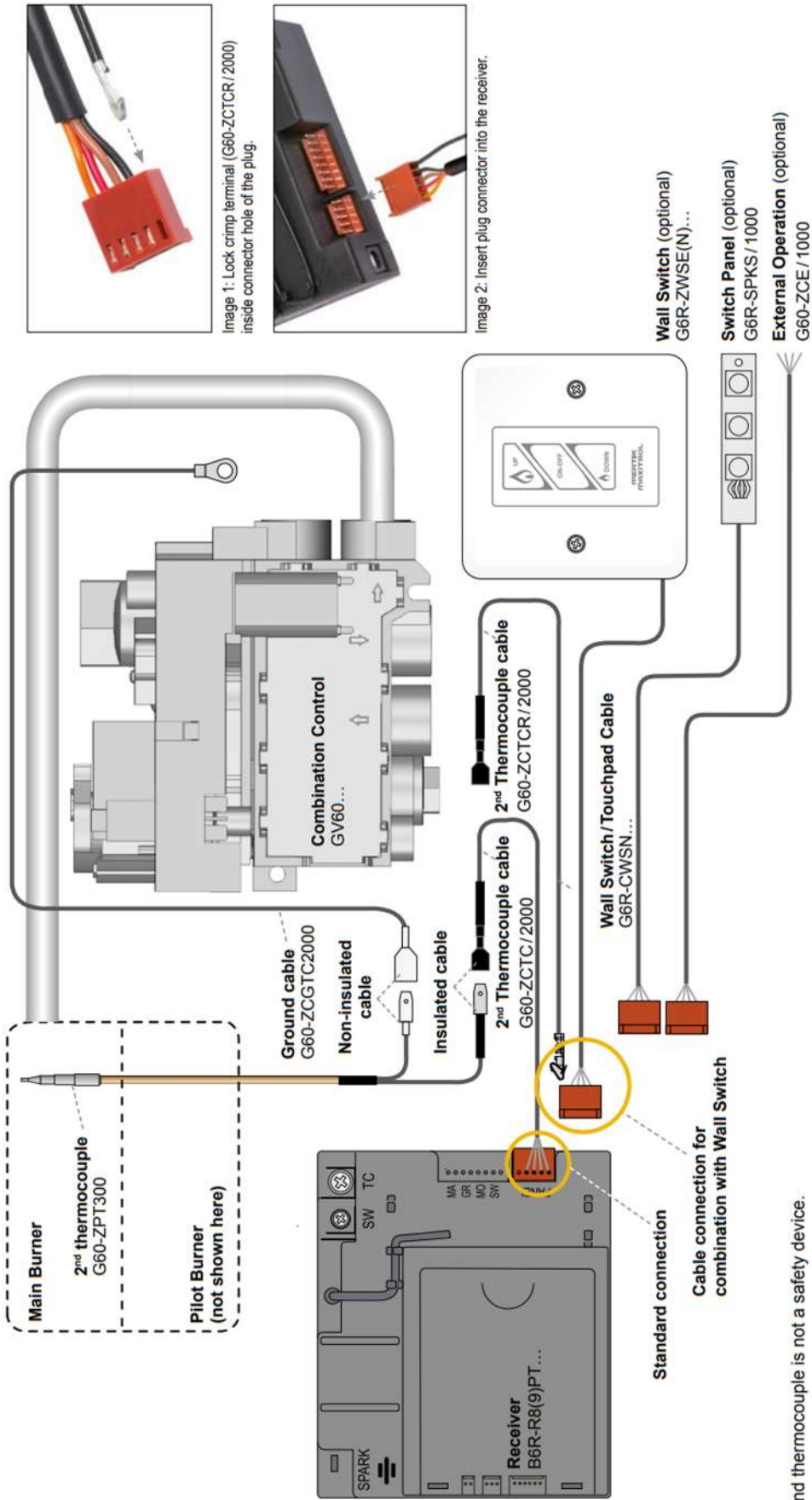

The 2nd thermocouple is not a safety device.

Connection of a 2nd thermocouple

- A 2nd thermocouple is placed in the main burner to check that the main gas is ignited within a certain time after opening.
- The voltage is measured for 22 sec after the motor has turned to high fire (during ignition and after increasing flame height). If the voltage is lower than 1.8 mV, the electronics shut off the gas flow. A new ignition is blocked for 2 minutes after ignition failure and 1 minute after failure while opening main gas.
- Receivers for 2nd thermocouple are identified with a yellow sticker on the back. They will not operate without the thermocouple connected. Other versions will not operate if the thermocouple is connected.
- To use Wall Switch, Switch Panel or External Operation Cable, the additional G60-ZCT-CR/2000 cable is needed.

To install the 2nd thermocouple make sure that the insulated male spade is connected to the insulated female spade. The non-insulated male spade must be connected to the female spade ground cable. The ground cable should be connected to the ground at the valve or the heater.

COMBINATION WITH WALL SWITCH

1. Remove G60-ZCTC/2000 cable and replace with Wall Switch/Touchpad G6R-CWSN... cable.
2. Insert the crimp terminal of the G60-ZCTCR/2000 cable into the open connector hole of the plug (see image 1). Listen for a "click".
3. Insert the insulated receptacle into the insulated 2nd thermocouple terminal.
4. Insert the plug connector into the receiver (see image 2).



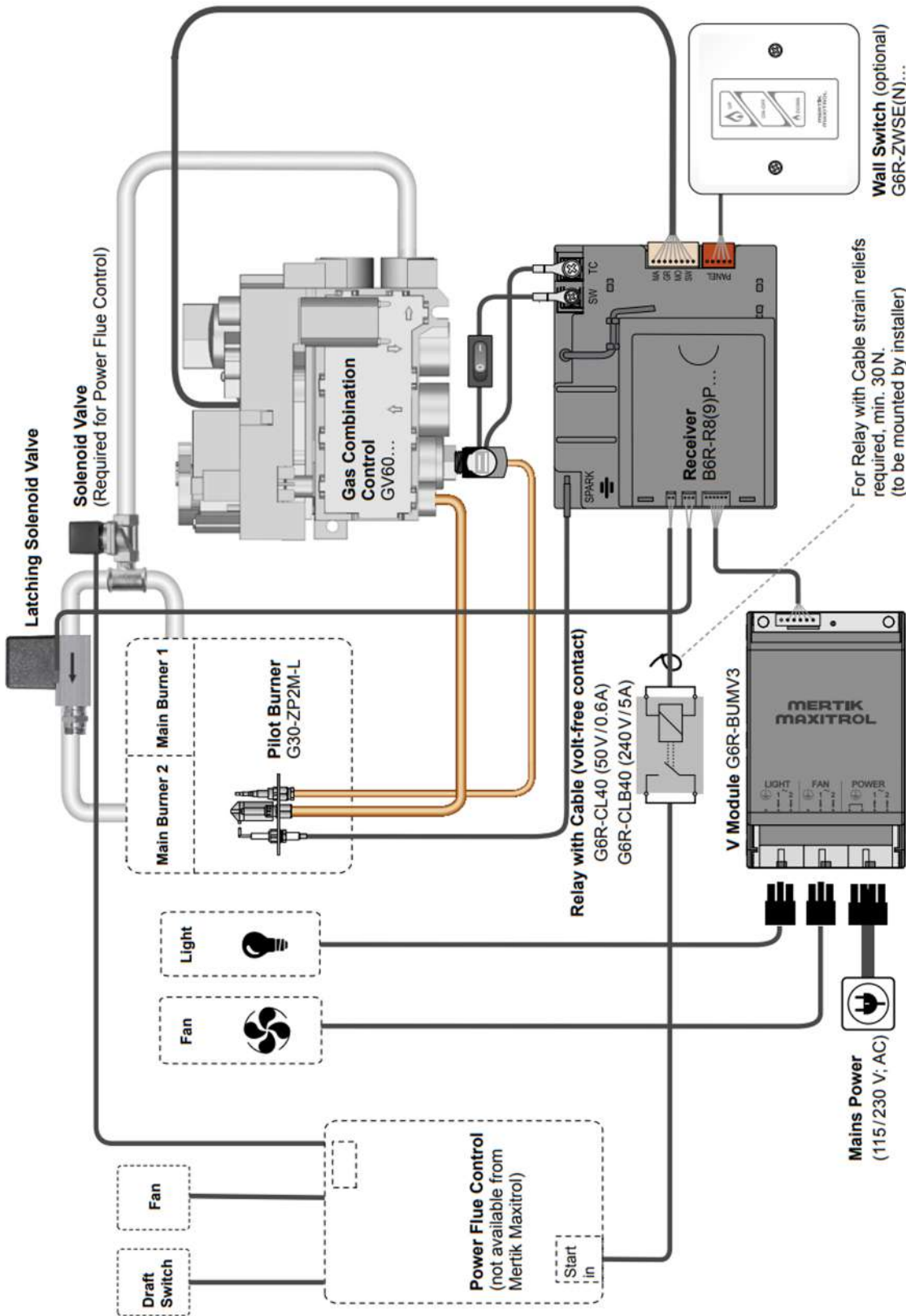

For Relay with Cable strain reliefs required, min. 30 N. (to be mounted by installer)

- Power Flue Control, solenoid valve, fan and pressure switch are not available from Mertik Maxitrol. The Power Flue Control operates the fan and the solenoid valve and checks the pressure switch. When there is the required draft, the solenoid valve opens. For safety, the solenoid valve must close in case of power outage.
- The B6R starts the Power Flue Control with the ignition sequence and when the motor leaves the pilot gas position and stops it at shut off and in pilot position.
- The receiver has an additional connection to start the power flue control.
- With a bistable relay at the cable the receiver controls the start function of a Power Flue Control.
- A solenoid valve must be installed downstream from the GV60. In case a 2nd burner is installed, the Solenoid Valve has to close both burners. If the Solenoid Valve is installed upstream of the valve a pilot gas position would not be possible.



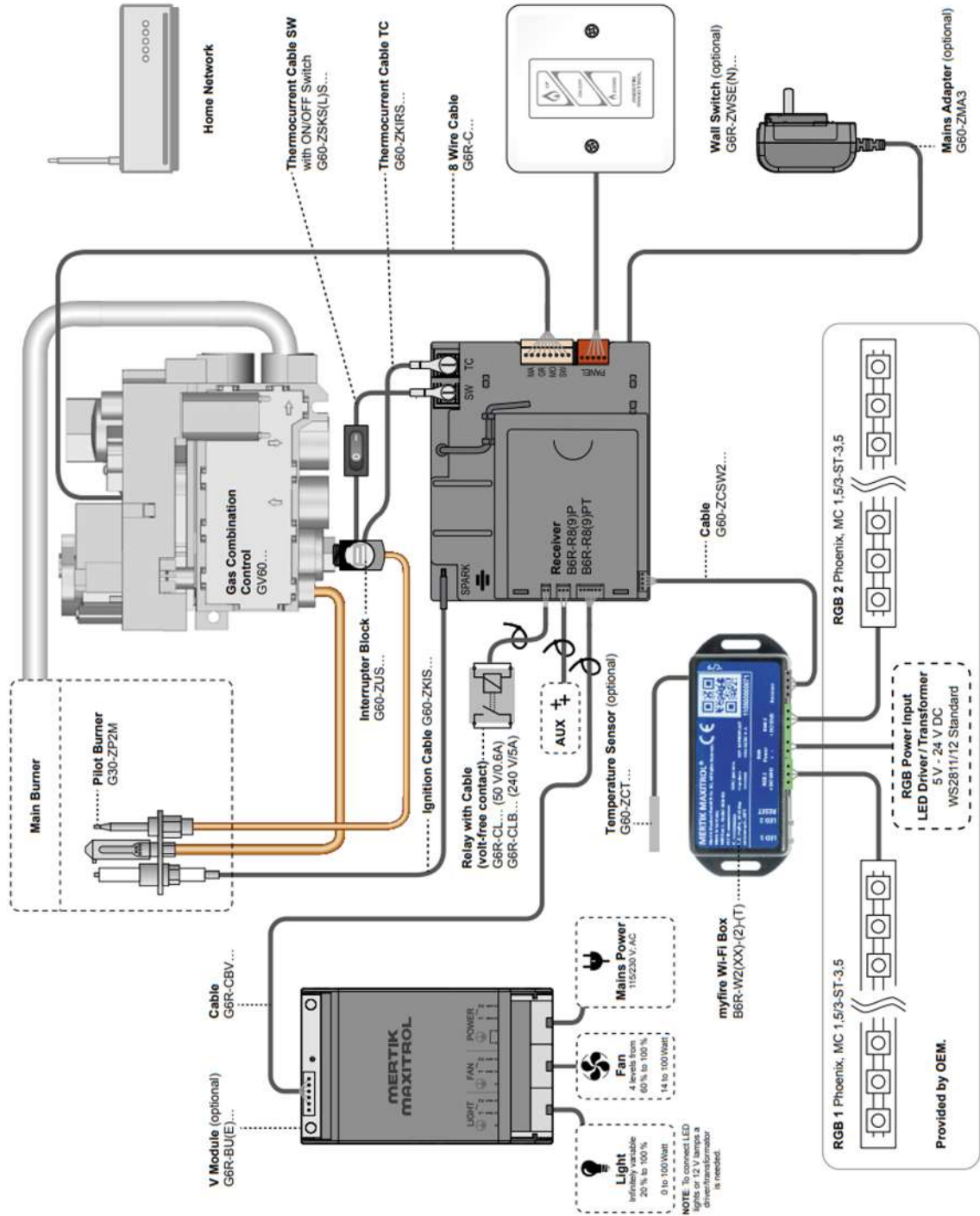

Mobile Device with myfire App (Android/iOS)

REQUIRED HANDSET



The Puck - Handset (optional) B6R-H8(9)SP...

OR



Symax Handset (optional) B6R-H8(9)...P...D...



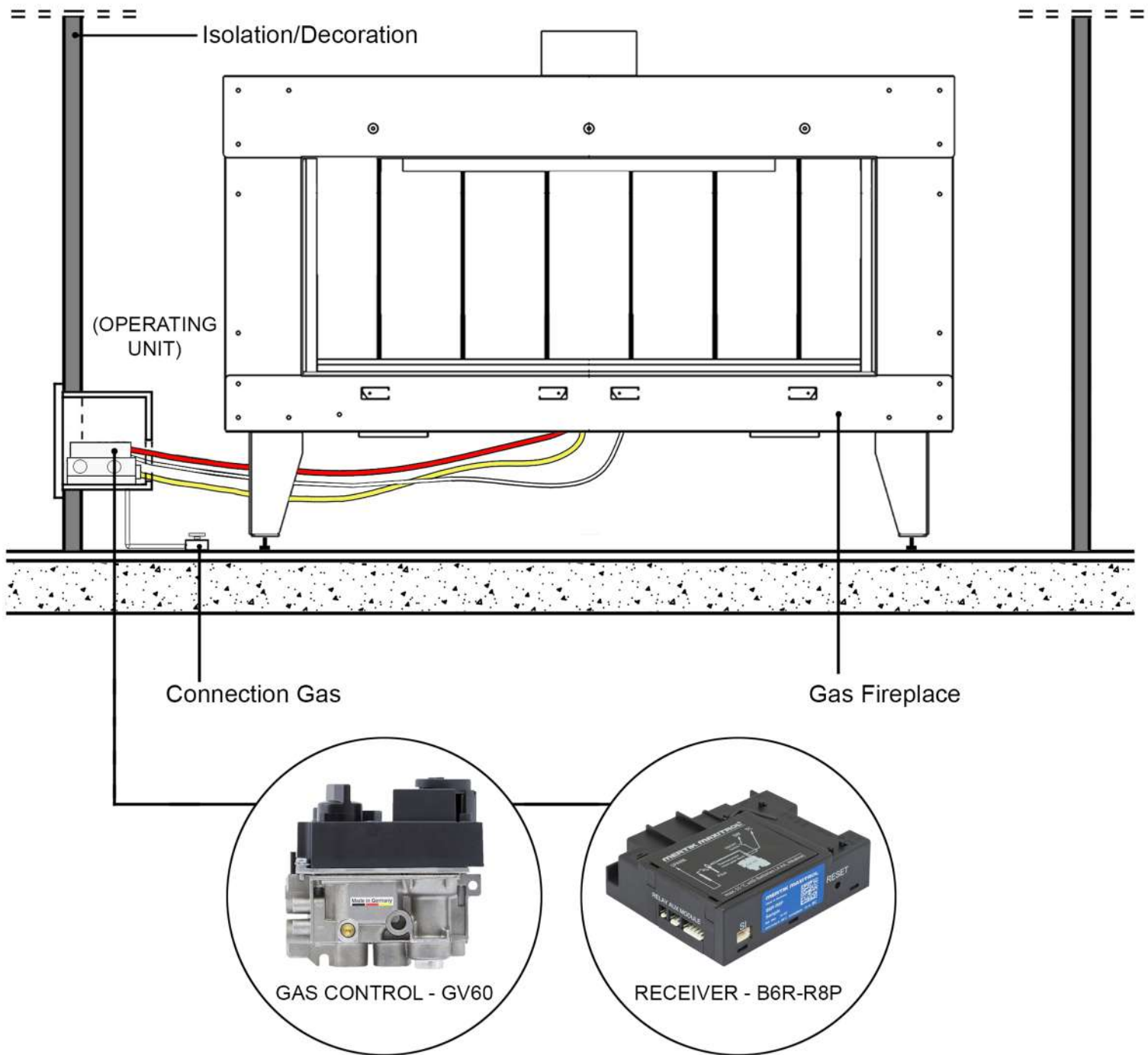

MAXITROL SYSTEM

The fireplace is connected to a built-in operating unit: it includes the GV60 and a receiver. However the fireplace is connected also to a bottle of gas, it could be natural, propane or butane gas.



The concentric flue could be installed in two ways, with a roof exit or a wall exit.

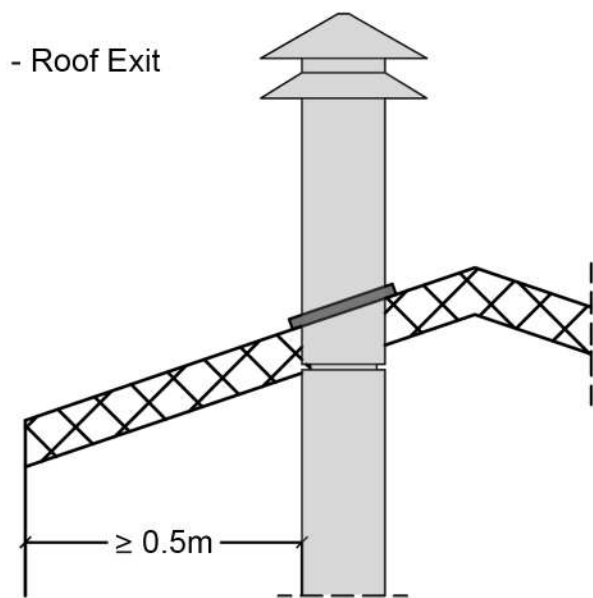
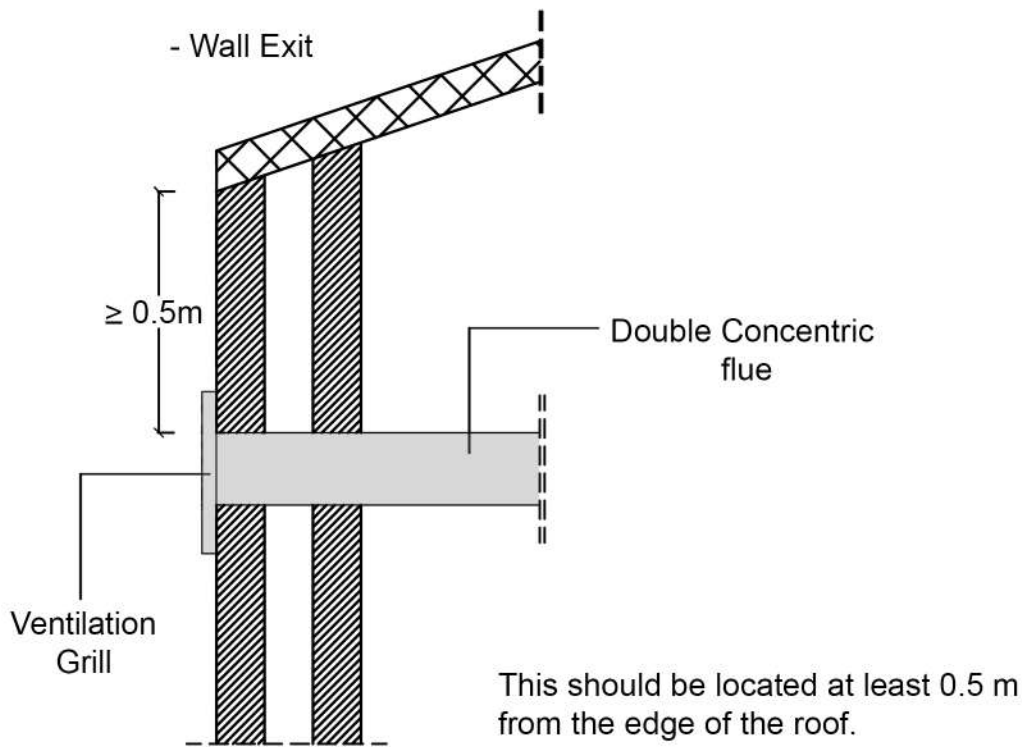

This must be installed at least 0.5 m from:

- the corner of the building.
- the roof overhang, the rain gutter.
- balconies etc., unless the exhaust construction extends to at least the face of the protruding section.



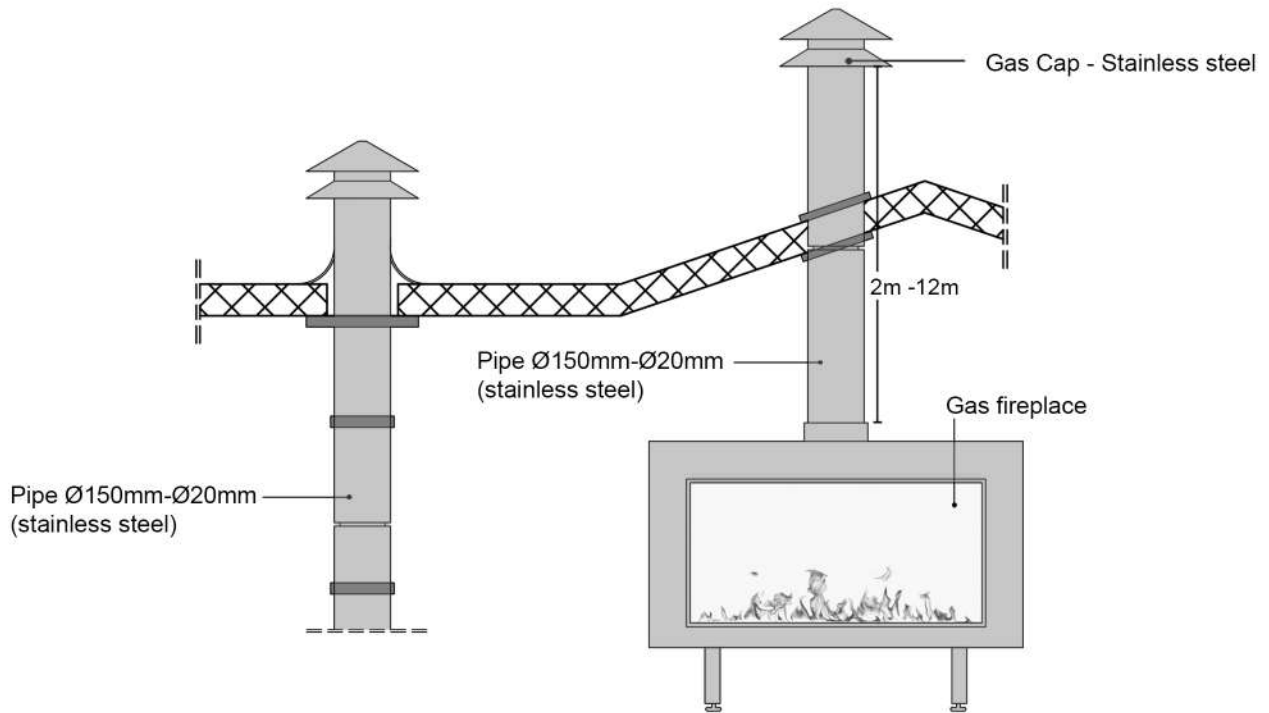

- Roof Exit with a bend:

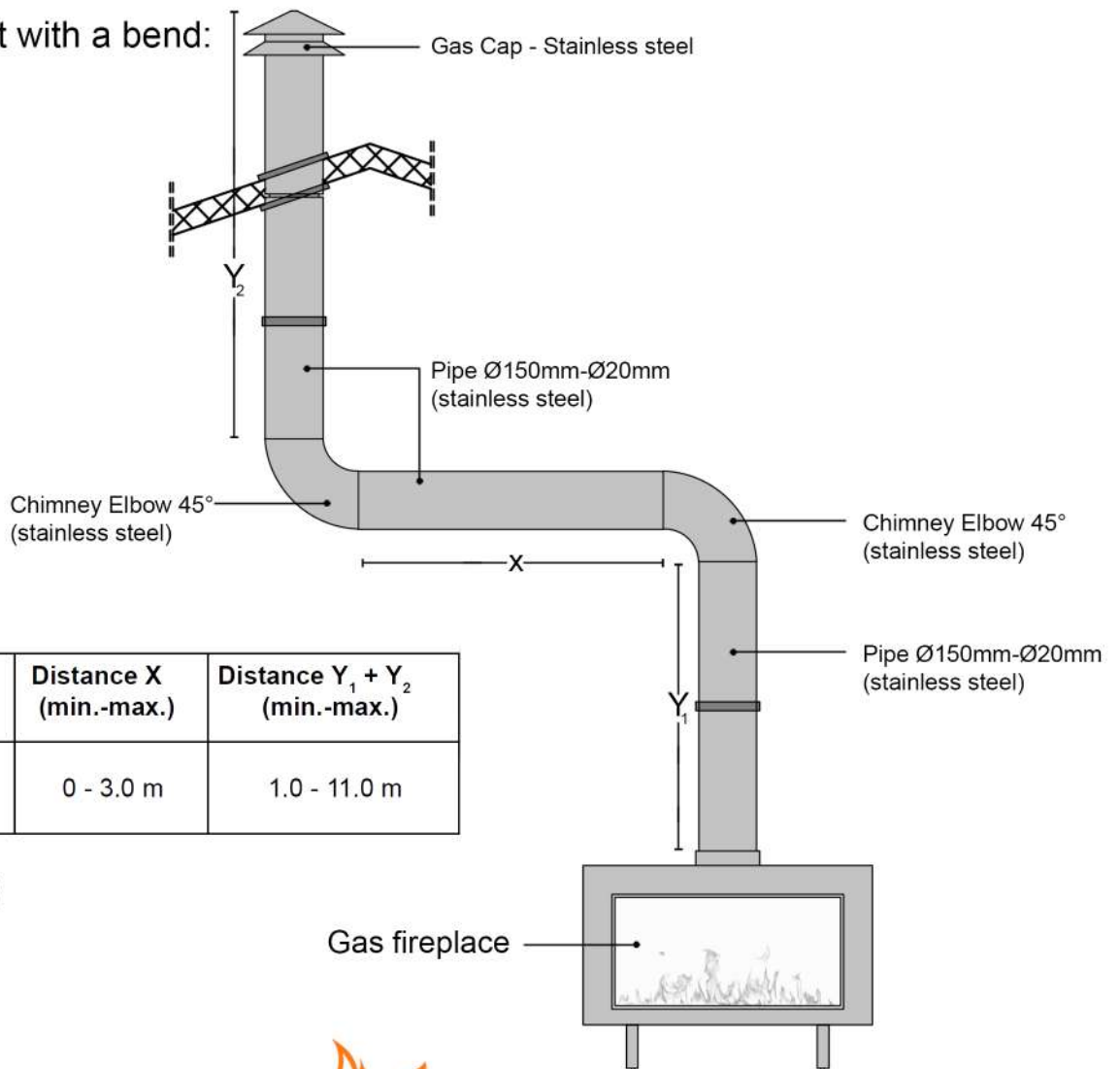

Distance Y ₁ (min.-max.)	Distance X (min.-max.)	Distance Y ₁ + Y ₂ (min.-max.)
1.0 - 11.0 m	0 - 3.0 m	1.0 - 11.0 m

$(Y_1 + Y_2) : X > 2$



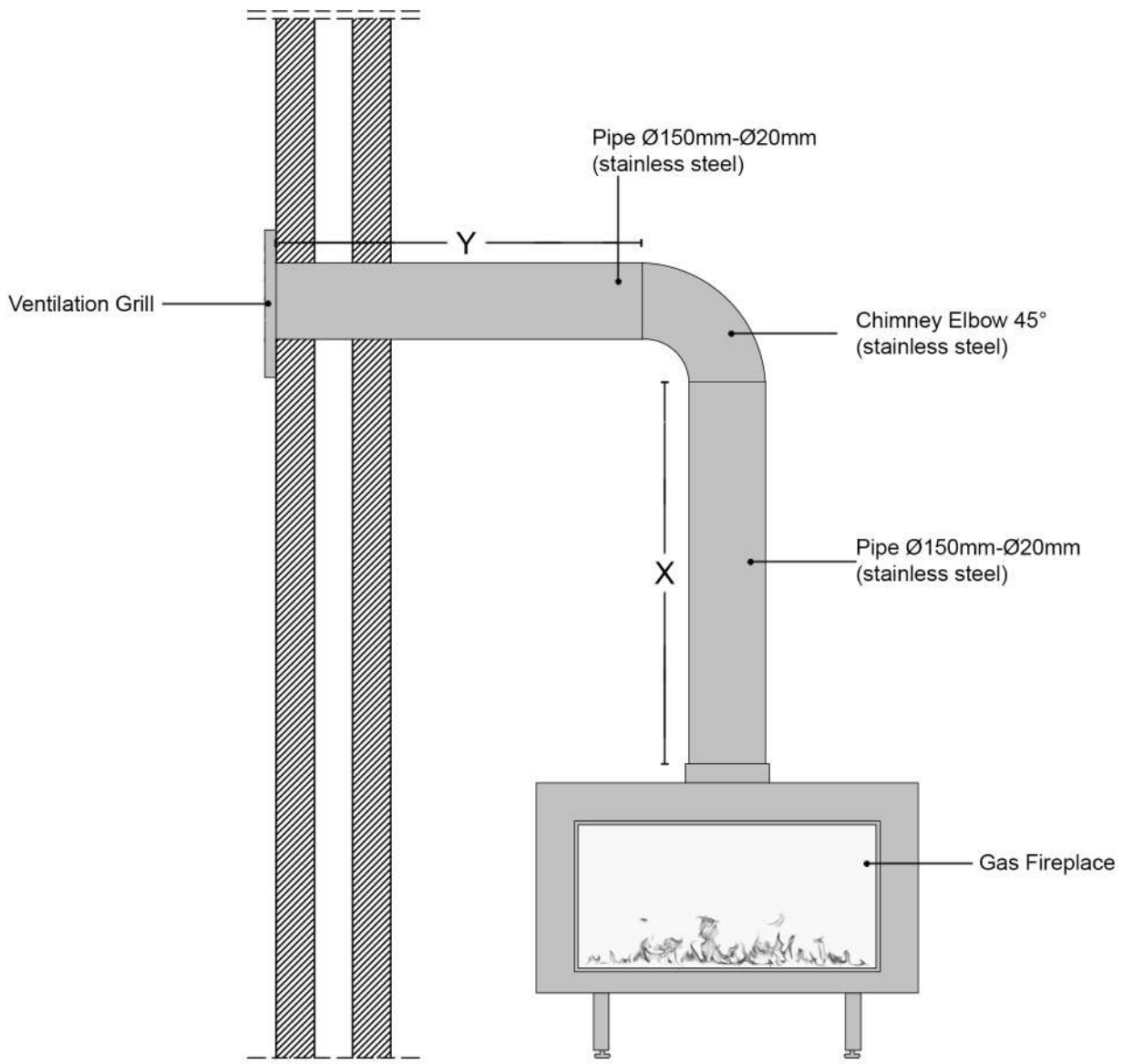

Distance Y (min.-max.)	Distance X (min.-max.)
0 - 0.5 m	0 - 0.6 m
0.5 - 3.0 m	0 - 3.6 m
1.0 - 3.0 m	3.6 - 8.6 m



-TV Installation above mantelshelf:

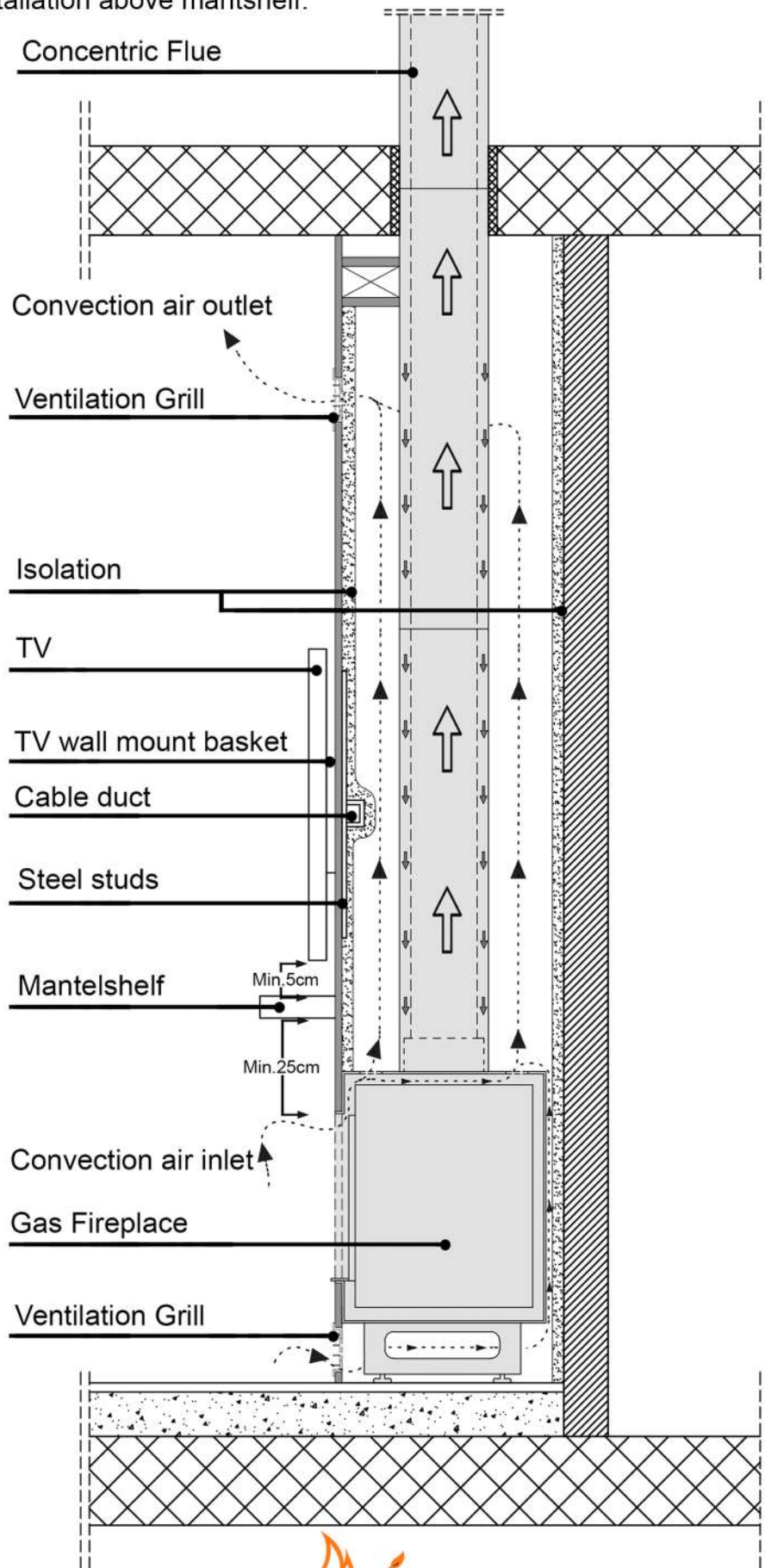

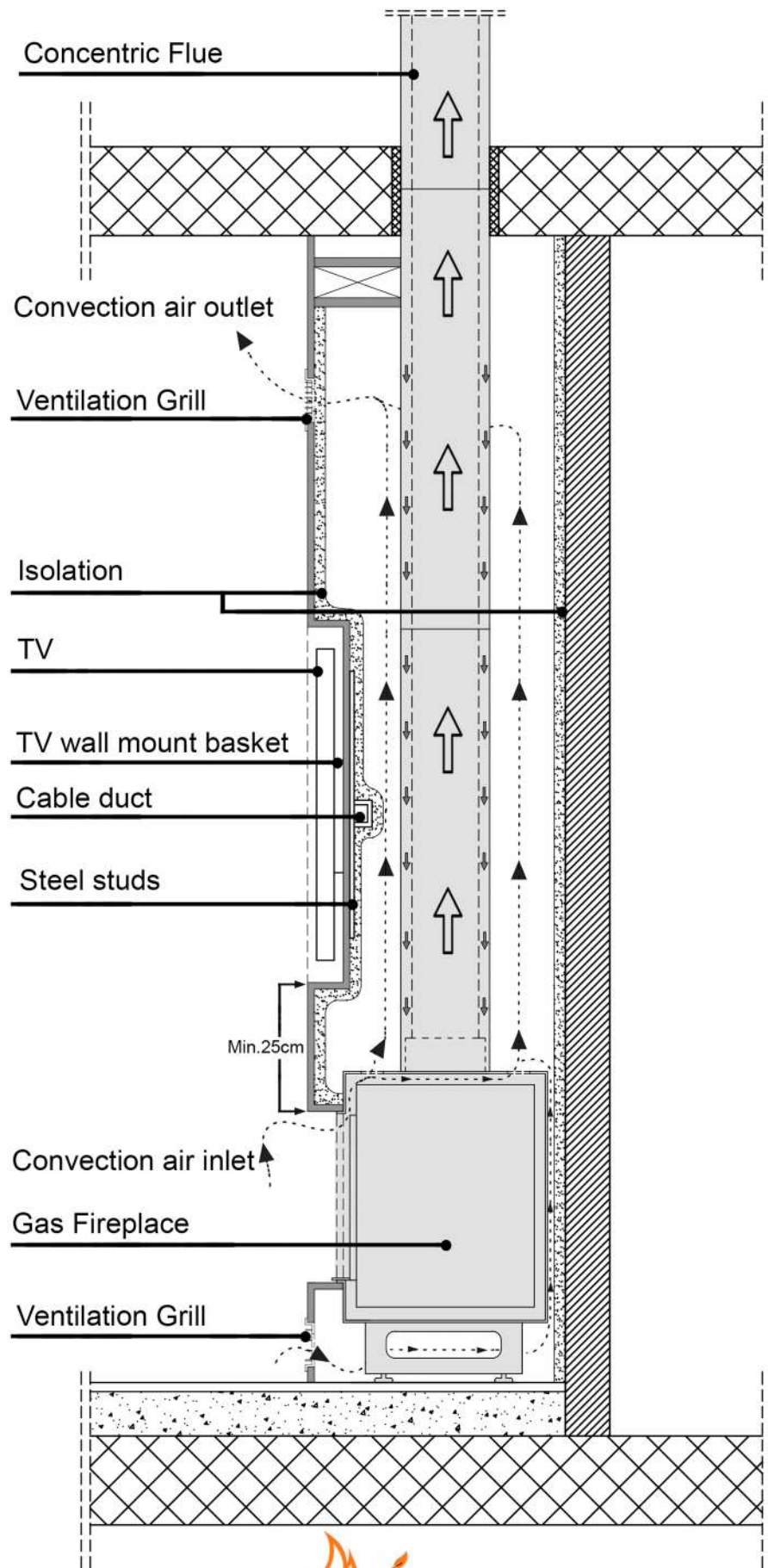

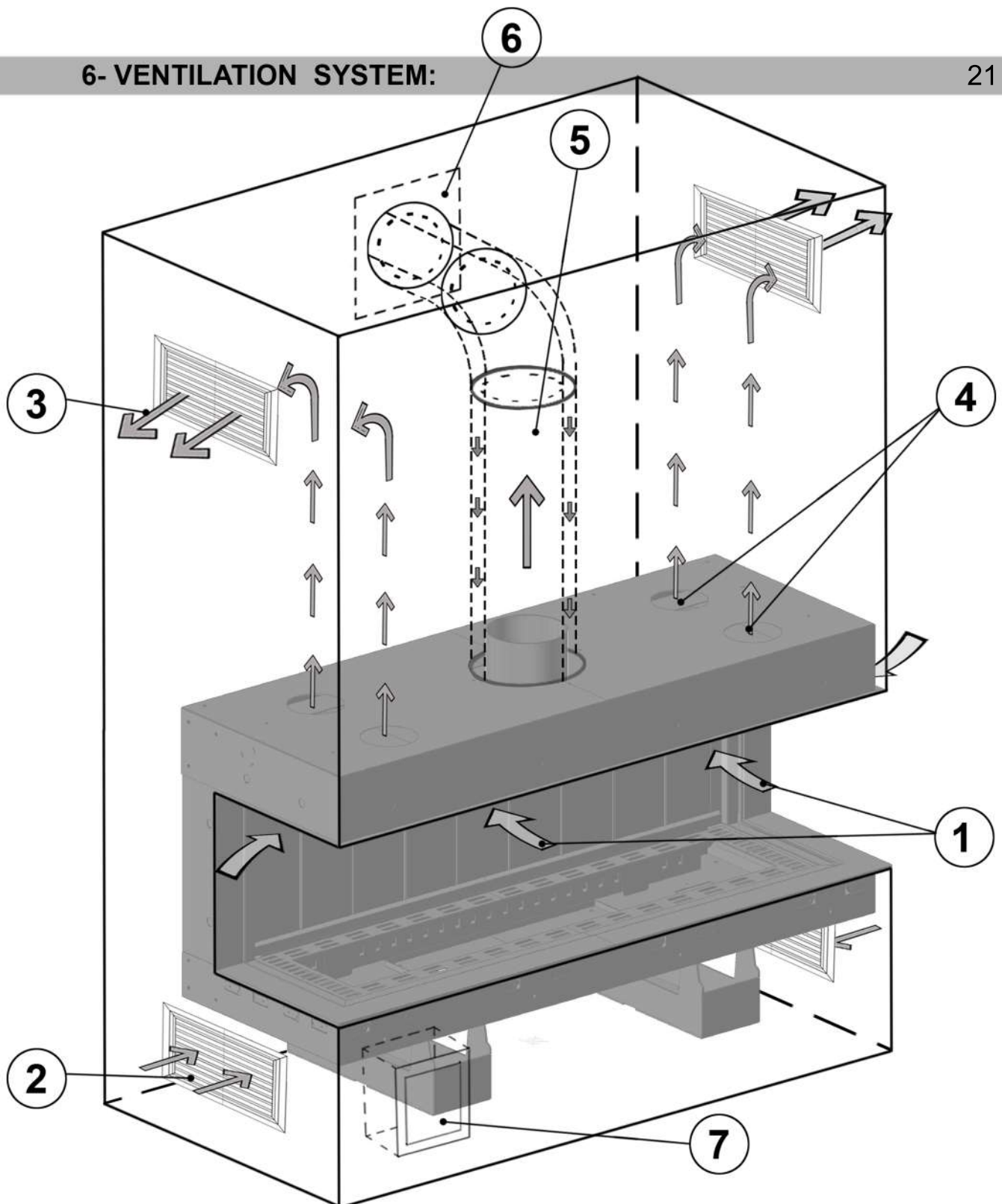

- 1- Convection air inlet (Fireplace).
- 2- Convection air inlet (Grill).
- 3- Outlet opening(Grill) for convection air.
- 4- Outlet opening (Fireplace) for natural convection air.
- 5- Concentric flue $\text{\O}150\text{-}200$ mm for a horizontal wall outlet.
- 6- Horizontal outlet grill for convection air.
- 7- Built-in unit for the receiver and regulator (system).



Gas burner - built in

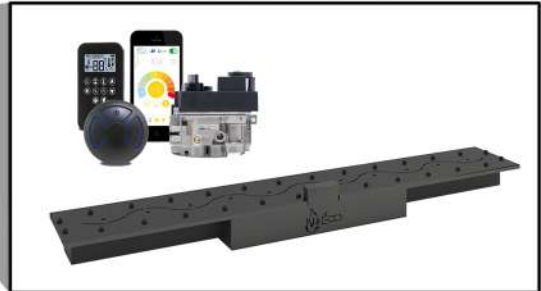

The burner is built into the fireplace, connected to the gas system - Maxitrol system. You can decorate your fireplace with: ceramic/concrete log, ceramic pebbles, embers, vermiculite.



Keep the pilot light burner unblocked



Ceramic Ember Black



Ceramic pebble set black



Vermiculite



Ceramic Log



THREE SIDED FRAMELESS GAS FIREPLACE

-Glass Dimensions:

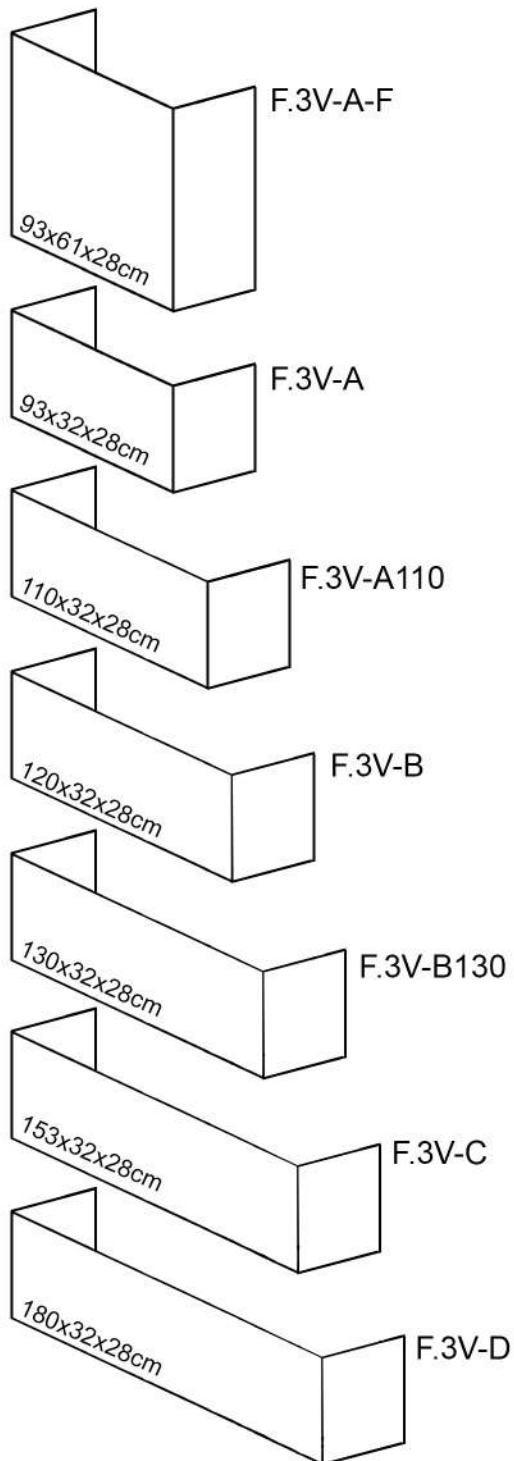

-F.3V-A-F

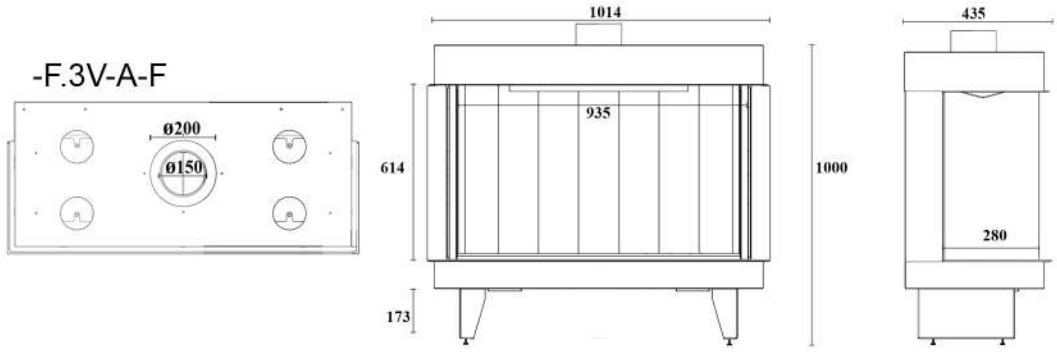

-F.3V-A

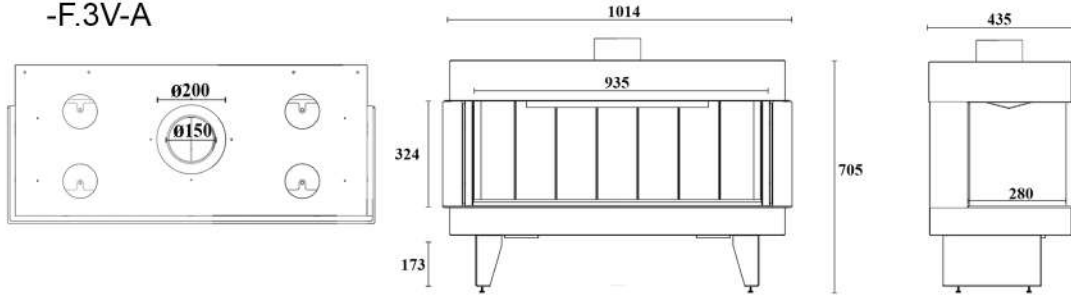

-F.3V-A110

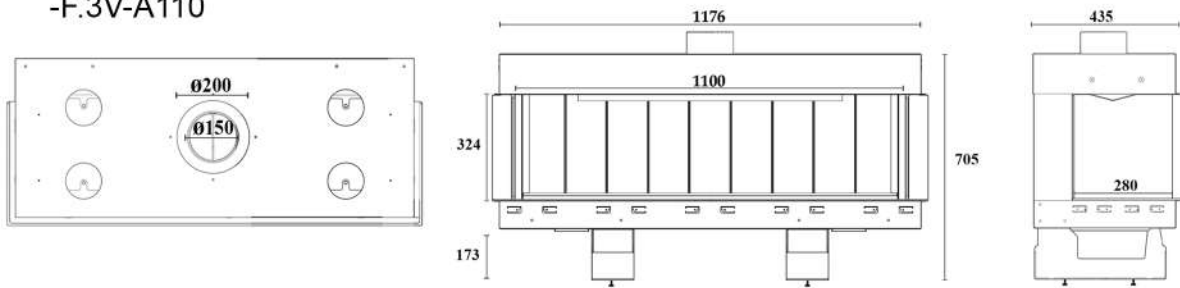

-F.3V-B

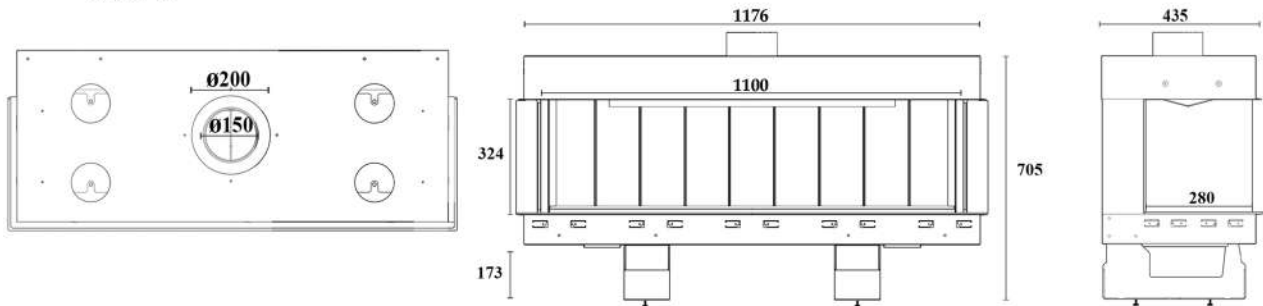

-F.3V-B130

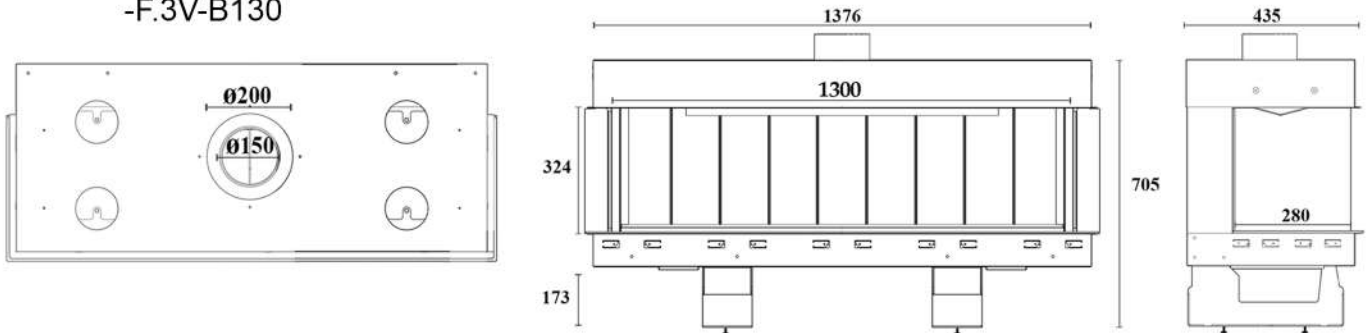

F.3V-C

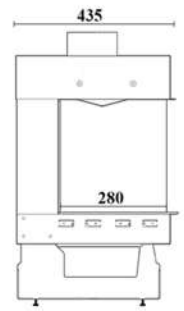
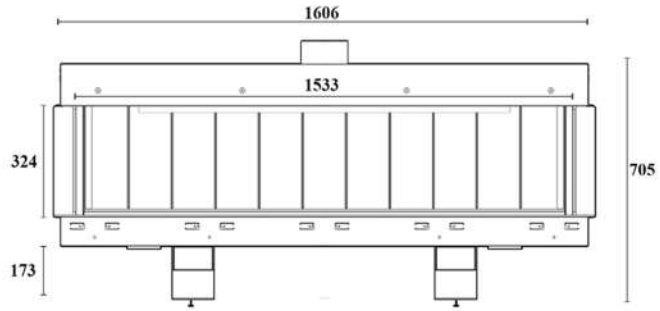
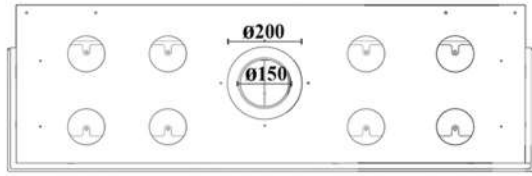

F.3V-D

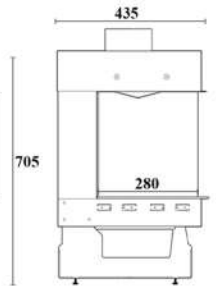
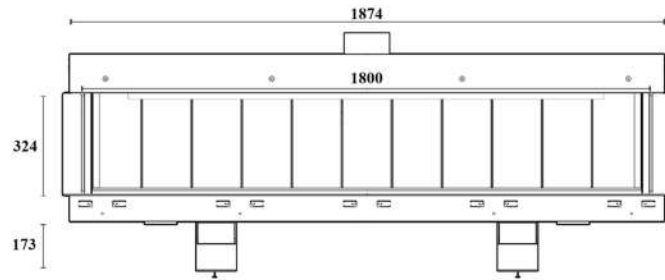
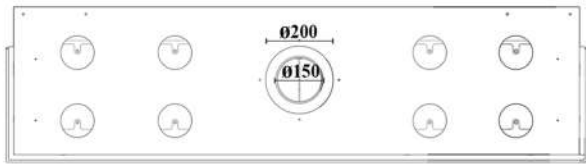



FLAMME ROUGE

Lebanon, Jbeil, Halat Main Road,
Bassam Bassil Building.

Tel: (00 961) 9 478 985

Fax: (00 961) 9 478 986

email: info@flammerouge-lb.com

Website: www.flammerouge-lb.com