

# QUEENA-WOOD STOVES



QS 95-70 FS



77Kg



16 KW



65CM

Queena  
STOVE



■ Combustion chamber vermiculite

○ Chimney Diameter 20 CM

CE Certificate NO:9844

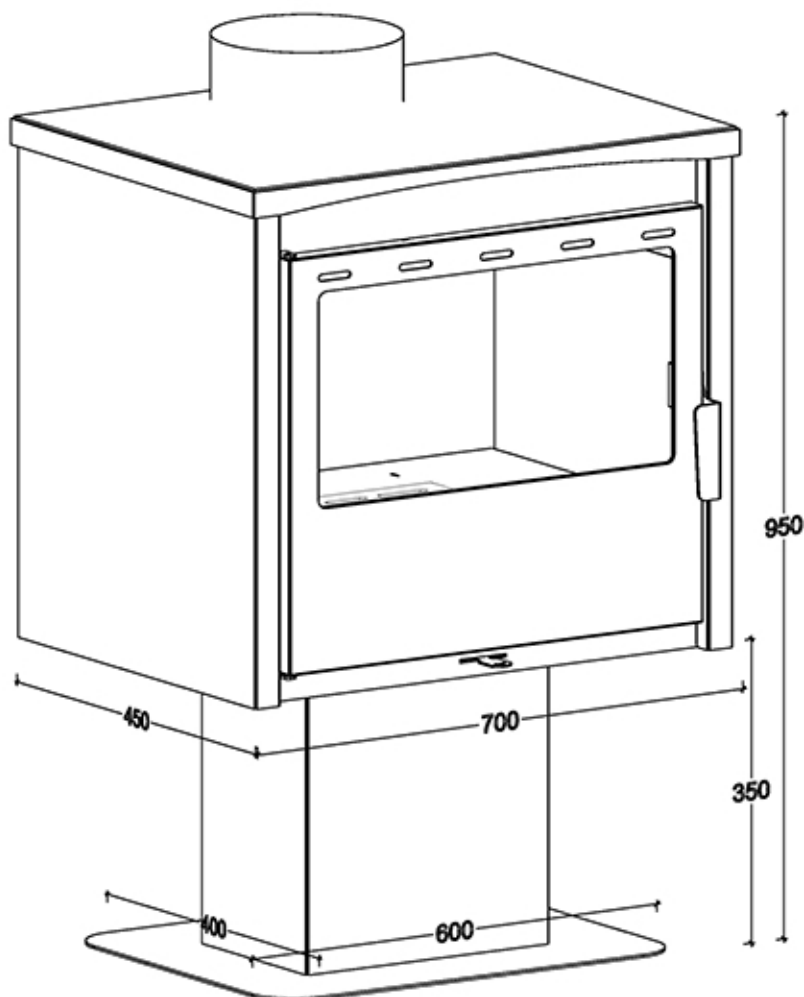

FLAMME ROUGE

Halat-Highway- Tel:09.478985/6 - 03.880633 70.210222 70.250500

www.flammerouge-lb.com E: info@flammerouge-lb.com